

Complex Areas

7th Grade Math

Name: _____

Evaluate the area of the shaded region. You must show your work!

1)

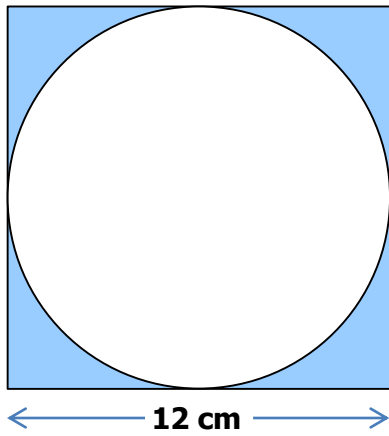

2)

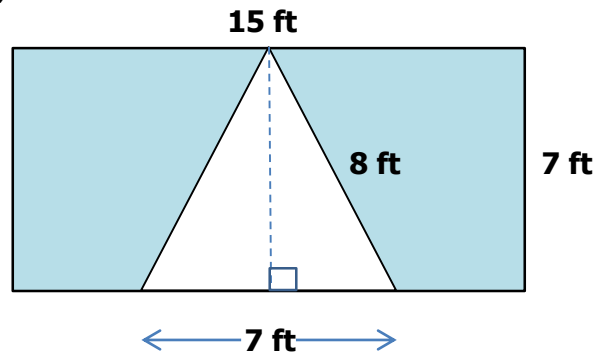

3)

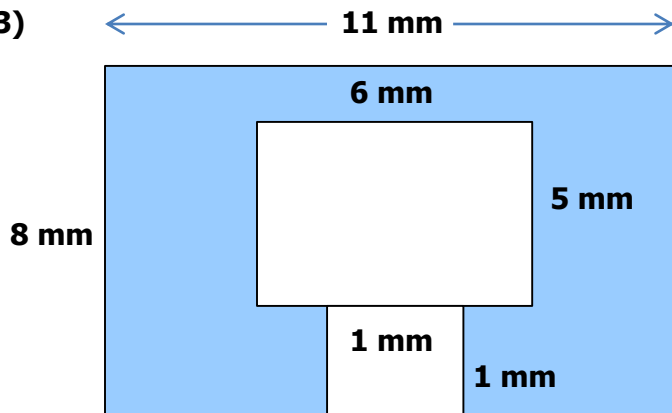

4)

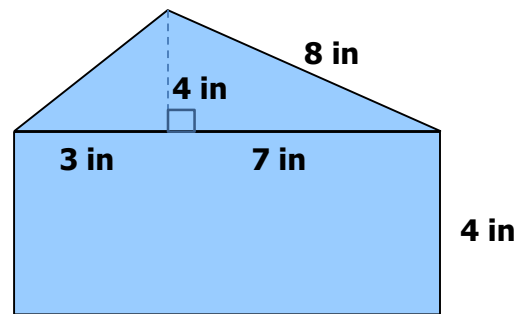

5)

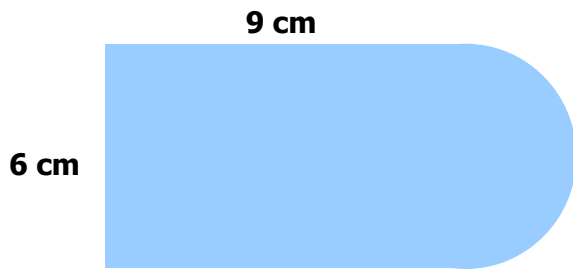

6)

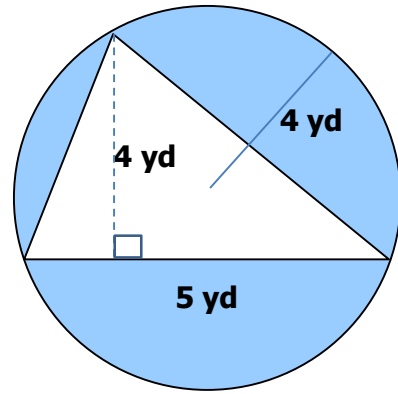

7)

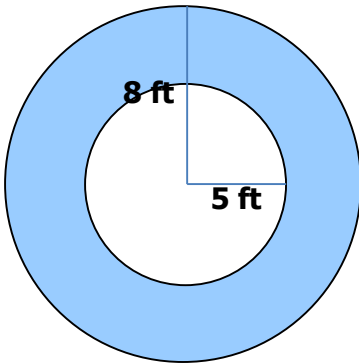

8)

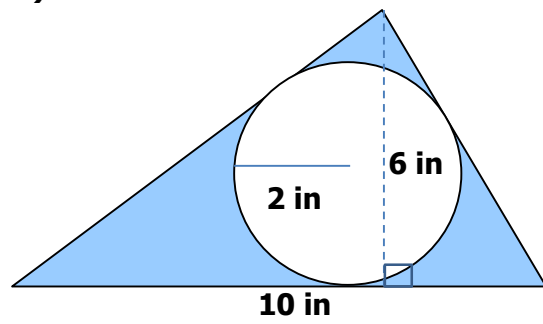

9)

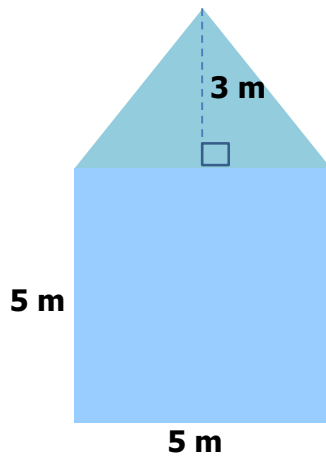

10)

